

DATA SHEET

MULTILAYER CERAMIC CAPACITORS

CC Series
X7R
16 V TO 100 V



SCOPE

This specification describes Yageo CC X7R series chip capacitors.

ORDERING INFORMATION

Part number is identified by the series, size, tolerance, packing style, temperature coefficient, rated voltage and capacitance value.

CC XXXX X X **X7R** X **BB** XXX
 (1) (2) (3) (4) (5)

(1) SIZE – INCH BASED (METRIC)

- 0402 (1005)
- 0603 (1608)
- 0805 (2012)
- 1206 (3216)
- 1210 (3225)
- 1812 (4532)

(2) TOLERANCE

- J = ±5%
- K = ±10%

(3) PACKING STYLE

- R = 7" paper tape
- K = 7" blister tape
- P = 13" paper tape
- F = 13" blister tape
- C = Bulk case

(4) RATED VOLTAGE

- 7 = 16 V
- 8 = 25 V
- 9 = 50 V
- 0 = 100 V

(5) CAPACITANCE VALUE:

- First two for significant figures and 3rd for number of zero
- Letter "R" for decimal point

CONSTRUCTION

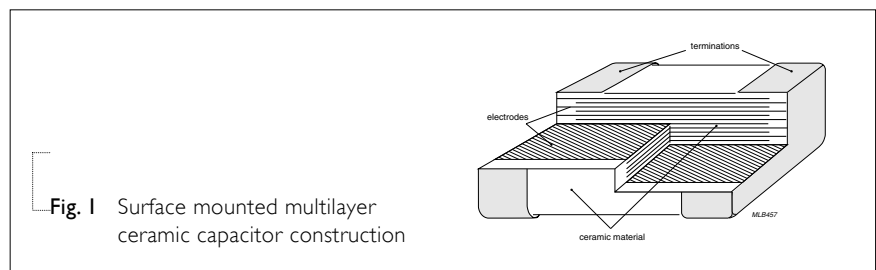

DIMENSION

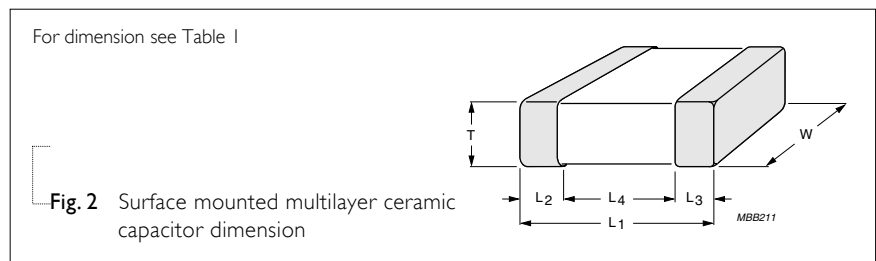

Table I

TYPE	CC0402	CC0603	CC0805	CC1206	CC1210	CC1812
L₁ (mm)	1.0±0.05	1.6±0.10	2.0±0.10	3.2±0.15	3.2±0.20	4.5±0.20
W (mm)	0.5±0.05	0.8±0.07	1.25±0.10	1.6±0.15	2.5±0.20	3.2±0.20
T (mm)	min. 0.45	0.73	0.50	0.50	0.50	0.50
	max. 0.55	0.87	1.35	1.35	1.80	1.80
L₂/L₃ (mm)	min. 0.15	0.20	0.25	0.25	0.25	0.25
	max. 0.30	0.60	0.75	0.75	0.75	0.75
L₄ (mm)	min. 0.40	0.40	0.55	1.40	1.40	2.20

CAPACITANCE RANGE & THICKNESS FOR 16V & 25V

Table 2

CAPACITANCE (nF)	16 V 0402	0603	0805	1206	25 V 0402	0603	0805	1206	1210
3.3					0.5 ±0.05				
3.9									
4.7									
5.6									
6.8	0.5 ±0.05								
8.2									
10						0.8 ±0.07	0.6 ±0.1		
12									
15									
18									
22									
27									
33		0.8 ±0.07							
39									
47			0.6 ±0.1				0.85 ±0.1		
56									
68									
82			0.85 ±0.1						
100								0.85 ±0.1	
120									
150									
180									
220				0.85 ±0.1					0.85 ±0.1
270								1.15 ±0.1	
330			1.25 ±0.1						
390				1.15 ±0.1					
470									
560									
680									
820									
1,000									

CAPACITANCE RANGE & THICKNESS FOR 50V & 100V

Table 3

CAPACITANCE (nF)	50 V 0402	0603	0805	1206	1210	1812	100 V 0805	1206	1210	1812
0.10	0.5 ±0.05	0.8 ±0.07								
0.12										
0.15										
0.18										
0.22			0.6 ±0.1	0.85 ±0.1			0.6 ±0.1	0.85 ±0.1		
0.27										
0.33										
0.39										
0.47										
0.56										
0.68										
0.82										
1.0										
1.2										
1.5										
1.8										
2.2										
2.7										
3.3										
3.9										
4.7										
5.6										
6.8										
8.2										
10					0.85 ±0.1					
12							0.85 ±0.1			
15										
18										
22										
27			0.85 ±0.1							
33										
39										
47									0.85 ±0.1	

CAPACITANCE RANGE & THICKNESS FOR 50V & 100V (CONTINUED)

Table 4

CAPACITANCE (nF)	50 V					100 V				
	0402	0603	0805	1206	1210	1812	0805	1206	1210	1812
56			0.85 ±0.1	0.85 ±0.1	0.85 ±0.1			1.15 ±0.1	0.85 ±0.1	
68										
82										
100		0.8 ±0.07				1.15 ±0.1				1.15 ±0.1
120					1.15 ±0.1				1.15 ±0.1	
150				1.15 ±0.1						
180										
220										
270										
330										
390										1.6 ±0.2
470										
560						1.6 ±0.2				
680										
820										
1,000										

THICKNESS CLASSES AND PACKING QUANTITY

Table 5

THICKNESS CLASSIFICATION (mm)	8mm TAPE WIDTH / AMOUNT PER REEL				12mm TAPE WIDTH / AMOUNT PER REEL	AMOUNT PER BULK CASE			
	Ø180mm, 7"		Ø330mm, 13"		Ø180mm, 7" Blister	1812	0402	0603	0805
	Paper	Blister	Paper	Blister					
0.5 ±0.05	10,000	---	50,000	---	---	50,000	---	---	---
0.6 ±0.10	4,000	---	20,000	---	---	---	---	---	10,000
0.8 ±0.07	4,000	---	15,000	---	---	---	15,000	---	---
0.85 ±0.10	4,000	---	15,000	---	---	---	---	---	8,000
1.15 ±0.10	---	3,000	---	10,000	---	---	---	---	---
1.25 ±0.10	---	3,000	---	10,000	---	---	---	---	5,000
1.6 ±0.20	---	---	---	---	1,000	---	---	---	---

ELECTRICAL CHARACTERISTICS

Table 5

CHARACTERISTICS	TEST CONDITIONS	REQUIREMENT
Operation temperature range	---	-55 °C to +125 °C
Temperature characteristic/coefficient (TC)	With respect to 20 °C within operation temperature range	±15%
Capacitance tolerance	1 Vrms/1 KHz at 20 °C	±5%, ±10%
Dissipation factor (Tan δ)	1 Vrms/1 KHz at 20 °C	25 V, 50 V & 100 V; ≤2.5% 16 V; ≤3.5%
Insulation resistance (IR)	At Ur (rated voltage) for 1 minute	C ≤ 10 nF; R _{ins} ≥ 10 GΩ C > 10 nF; R _{ins} × C ≥ 500 s
Dielectric withstanding Voltage	At 2.5 × Ur (for Ur ≤ 100V) 1.5 × Ur + 100 V for 5 sec	No breakdown

TAPING REEL

Table 6

TAPE WIDE	8mm	8mm	12mm
ØA (mm)	180	330	180
ØB (mm)	62±1.5	62±1.5	62±1.5
ØD (mm)	20.5	20.5	20.5
ØC (mm)	12.75±0.15/-0	12.75±0.15/-0	12.75±0.15/-0
W (mm)	8.4±1.5/-0	8.4±1.5/-0	12.4±2/-0
T _{max} (mm)	14.4	14.4	18.4

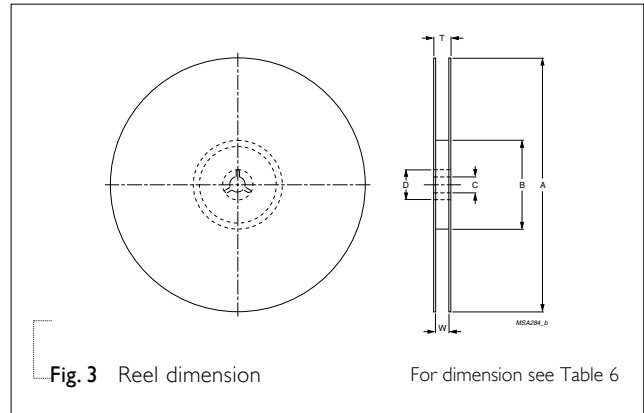

PAPER TAPE SPECIFICATION

Table 7

DIMENSION	0402	0603	0805	1206
A (mm)	0.62±0.05	1.10±0.05	1.65±0.05	2.0±0.1
B (mm)	1.12±0.05	1.90±0.05	2.4±0.05	3.5±0.1
W (mm)	8.0±0.2	8.0±0.2	8.0±0.2	8.0±0.2
E (mm)	1.75±0.1	1.75±0.1	1.75±0.1	1.75±0.1
F (mm)	3.5±0.05	3.5±0.05	3.5±0.05	3.5±0.05
P ₀ (mm)	4±0.05	4±0.05	4±0.05	4±0.05
P ₁ (mm)	2±0.05	4±0.1	4±0.1	4±0.1
P ₂ (mm)	2±0.05	2±0.05	2±0.05	2±0.05
ØD ₀ (mm)	1.5±0.1	1.5±0.1	1.5±0.1/-0	1.5±0.1/-0
T (mm)	0.6±0.05	0.95±0.05	0.95±0.05	0.95±0.05

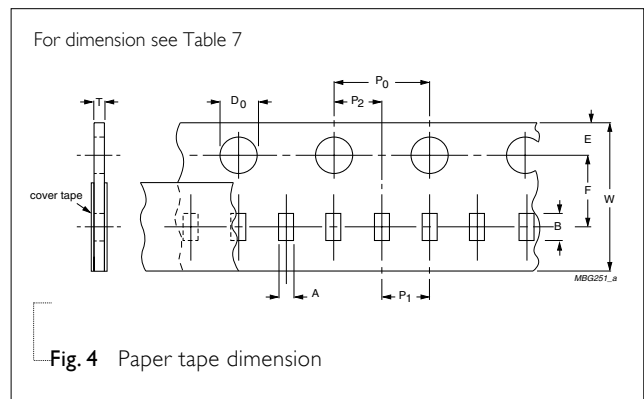

BLISTER TAPE SPECIFICATION

Table 8

DIMENSION	0805	1206	1210	1812
A (mm)	0.20	0.30	0.30	0.40
B (mm)	0.20	0.30	0.30	0.40
W (mm)	8.1±0.2	8.1±0.2	8.1±0.2	12.0±0.2
E (mm)	1.75±0.1	1.75±0.1	1.75±0.1	1.75±0.1
F (mm)	3.5±0.05	3.5±0.05	3.5±0.05	5.5±0.05
P ₀ (mm)	4±0.1	4±0.1	4±0.1	4±0.1
P ₁ (mm)	4±0.1	4±0.1	4±0.1	8±0.1
P ₂ (mm)	2±0.05	2±0.05	2±0.05	2±0.05
ØD ₀ (mm)	1.5±0.1/-0	1.5±0.1/-0	1.5±0.1/-0	1.5±0.1/-0
T _{max} (mm)	3.5	3.5	3.5	3.5

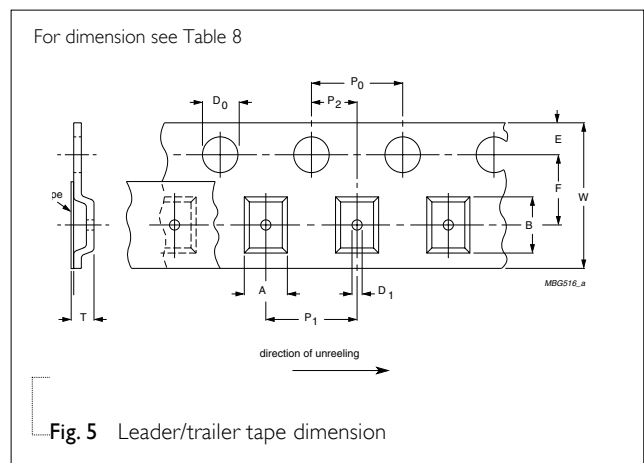

PACKING METHOD

LEADER/TRAILER TAPE SPECIFICATION

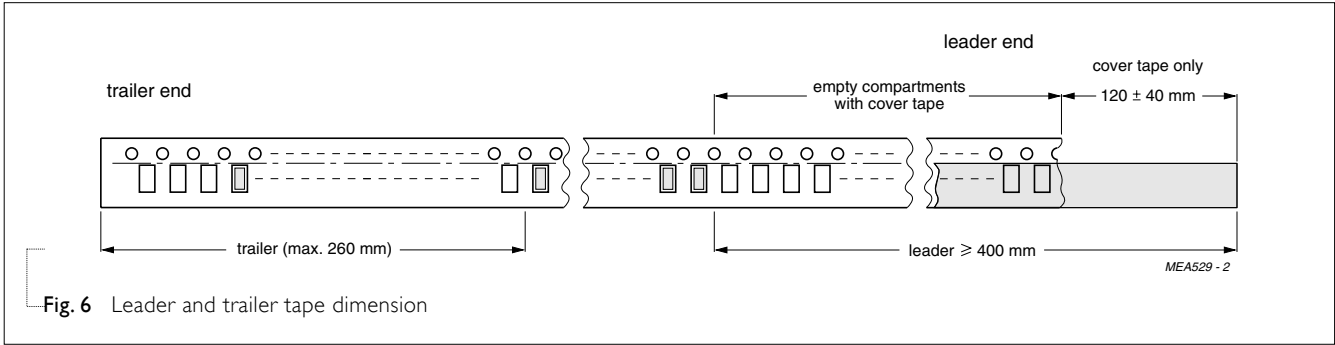

METHOD OF MOUNTING

For normal use the capacitors may be mounted on printed-circuit boards or ceramic substrates by applying wave soldering, reflow soldering (including vapor phase soldering) or conductive adhesive in accordance with CECC 00802 classification A.

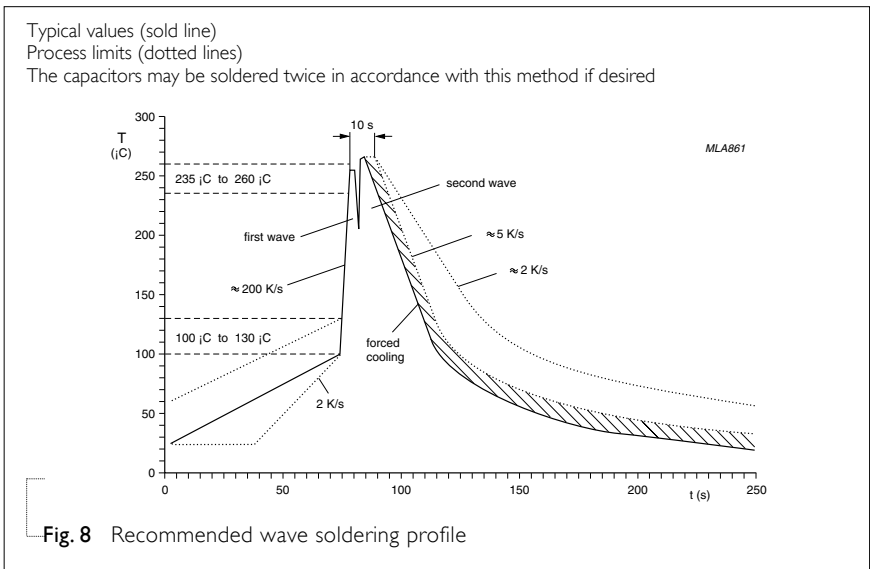
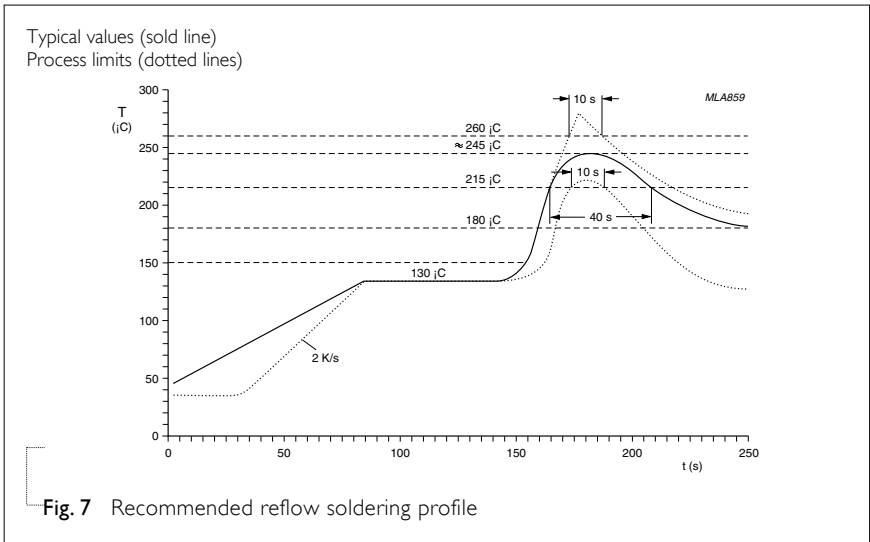

TEST AND REQUIREMENT

Table 9

IEC384-10	TEST ITEMS	CONDITIONS	REQUIREMENTS
4.9	Bending	Bending rate 1mm/s, jig. radius 340mm	$\Delta C/C \leq 10\%$
4.10	Resistance to soldering heat	260±5°C for 10±0.5s in static solder bath	$-5\% \leq \Delta C/C \leq 10\%$
4.11	Solderability	235±5°C for 2±0.5s in a static solder bath	75% minimum coverage of metallic area
4.12	Rapid change of temperature	Preconditioning -55°C to +125°C, 5cycles	$\Delta C/C$ within 15%
4.14	Damp heat	Preconditioning At 40°C, 90 to 95% RH and Ur applied (max. 500V) for 500 hours	$\Delta C/C$ within 15% Tan $\delta \leq 7\%$ $IR \geq 500M\Omega$ or $RxC \geq 25s$ whichever is less
4.15	Endurance	Preconditioning 2xUr applied for 1,000 hours, at upper category temperature	$\Delta C/C$ within 20% Tan $\delta \leq 7\%$ $IR \geq 1,000M\Omega$ or $RxC \geq 50s$ whichever is less

REVISION HISTORY

REVISION	DATE	CHANGE NOTIFICATION	DESCRIPTION
Version 9	Aug 17, 2005	-	- 0603 50V capacitance range extended to 100 nF
Version 8	Jan 21, 2005	-	- Capacitance range extended
Version 7	Feb. 24, 2004	-	- upgrade the thickness on page 3-4
Version 6	Aug. 13, 2003	-	- Taping drawing amended
Version 5	Jun. 19, 2003	-	- Thickness of 1206/470 nF revised into "1.15±0.1" - CTC code size 1812 revised
Version 4	Jan. 27, 2003	-	- Edit "SCOPE"
Version 3	Dec. 18, 2002	-	- New Yageo edition
Version 2	Jul. 04, 2002	-	-